

SEA.IQ

As standard in the basic version, the **SEA.IQ** color sorting machine from Cimbia offers the **highest multispectral Full-Color technology with built-in ultra-high resolution NIR infrared**, can be combined with **SWIR multispectral cameras** to meet the most demanding quality standards in any application sector

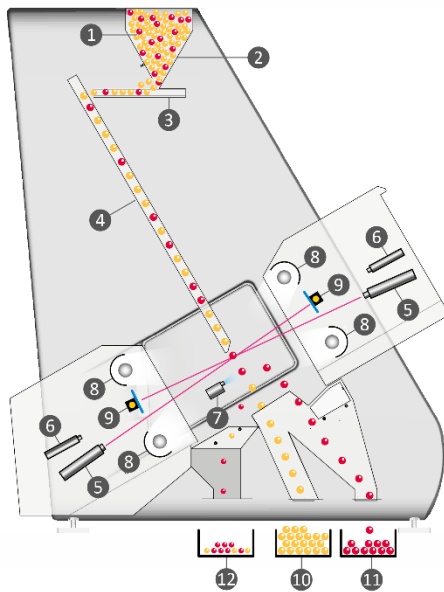
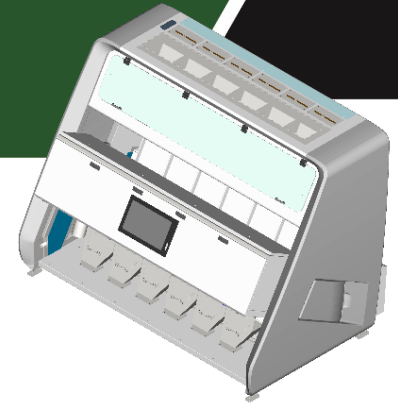

PROCESS

1. Product to sort
2. In-feed hopper
3. Vibrating feeder
4. Feeding chute
5. Full-Color cameras with integrated NIR
6. InGaAs cameras (optional)
7. Ejectors
8. Lights
9. Backlights
10. Sorted flow output
11. Reject flow output
12. Bounce output

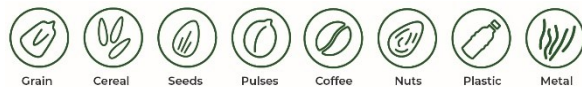

MAIN CHARACTERISTICS

- Up to 4 sections for simultaneous resorting
- Available configured with re-sorting, re-resorting or reverse sorting
- Image acquisition perfectly conform to reality
- Color analysis like that of the human eye
- Can be controlled and reprogrammed even remotely with the customer's specific recipes

ELECTRONICS

- Easy-to-replace electronic boards
- Auto-diagnostics and auto-calibration functions ensure operational best performances
- Ethernet connection allows real-time monitoring and remote assistance
- OPC System (option)

SISTEMA DI ESPULSIONE

- Standard 5 mm pitch - N.63 Ejectors per chute
- 3.3 mm pitch (option) - N. 96 Ejectors per chute
- Solenoid valves working speed up to 1,000 cycles /s, guaranteed up to 2 billion cycles
- Time and duration of ejection adjusted according to needs

OPTICAL SYSTEM

- The basic version uses Full-color RGB multispectral cameras with integrated NIR (front /back) with 4096 pixels. The inspection system recognizes 16 million colors plus infrared which combined with an optical resolution of 0.08 mm sees beyond the human eye
- Additional SWIR InGaAs cameras
- 25,000 Hz scan speed
- The software can check up to 14 families of defects
- Shape-sizing (shape control) integrated in the system
- Control and adjustment of the size of the defects
- Active LED light and background

MECHANICS

- 320 mm wide chutes
- Available from 1 to 6 channels
- Splitting of a channel in 50:50 (optional)
- Pressurization and airtight structure prevent dust entering
- Automatic programmable cleaning system
- Cooling system to grants the ideal temperature inside the optical boxes
- Simplified maintenance and cleaning
- Pre-arrangement for the aspiration system installation

SEA.IQ

HMI

- Windows 10® operating system allows easy use and smart connection to customer networks
- High visibility in low light conditions thanks to its HD 21,5" full color touch screen
- Intuitive graphics and multilingual interface to program and control recipes in an easy and fast way
- Easily customizable recipes with no storage limit, named according to the operator's needs
- Mark-good mark-bad function
- Out of good programming mode
- Active synoptic system with machine status (vibrators and sensitivity)
- Machine status and control of the production capacity
- Real-time statistics (e.g. rejects/s, throughput, reject/channel and others)
- Data backup

- Product control inside the hopper (level sensors)
- PLC status
- Alarms and instructions to restore functionality

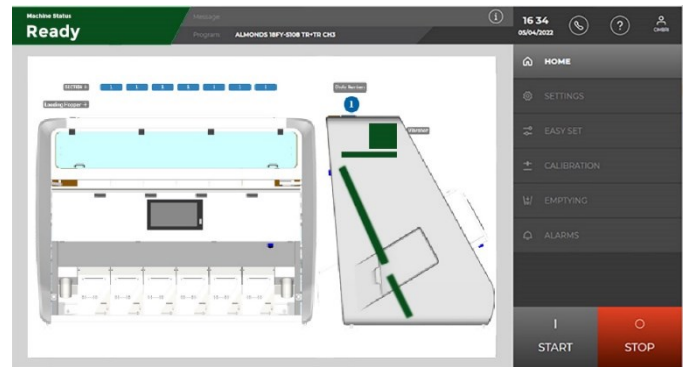

SEA.IQ CONFIGURATION

Front	
SEA.IQ	Standard version: Full-Color RGB cameras + integrated NIR /channel (front /back)
SEA.IQ R	Standard version + additional multi-frequency SWIR cameras on the back
SEA.IQ RR	Standard version + additional multi-frequency SWIR cameras on the front and rear

* On request, the pre-wired Plus version is available to accept additional cameras in future

EXTERNAL EQUIPMENT REQUIRED FOR THE CORRECT WORKING*

- 230 V - 50 Hz single-phase power supply
- Voltage stabilizer (strictly necessary)
- Pneumatic system including rotary compressor, tank, filters and dryer
 - ISO 8573-1:2010 [5:4:3] for NON-FOOD PRODUCTS *
 - ISO 8573-1:2010 [1.2.1] for FOOD PRODUCTS *¹
- 1" minimum diameter air supply hose
- Supporting frame (Minimum one meter of free space each sides)
- Infeed and discharging hoppers (optional Cimbria supply)
- Product conveyors systems
- Fast internet connection

* Customer must provide and install the above

*¹ Minimum legal requirements

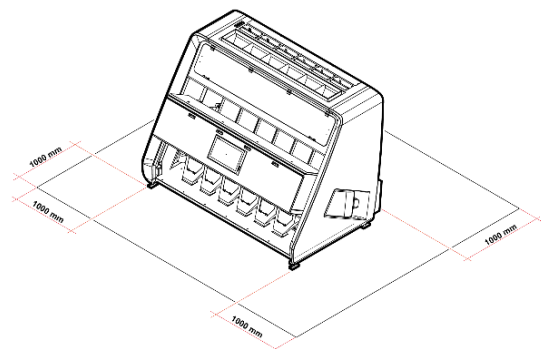







Leave at least one meter of free space around the sorter

DATI TECNICI

- White RAL 9003 Standard (custom colors as option)
- Working temperature in workrooms min +5°C max+35°C
- IP 55 protection
- CE conformity certificate
- 2006/42/CE on machinery safety
- 2014/30/CE on Electromagnetic Compatibility
- Compatible with UL and CSA standards
- ATEX standards Certificate (option)
- MOCA certificate (option)

MACHINE TECHNICAL DATA

		1	2	3	4	5	6
							
No. of vibrating feeders/chutes		1	2	3	4	5	6
No. of cameras (front+back)		2-4	4-8	6-12	8-16	10-20	12-24
No. ejectors/chutes 5 mm pitch		63	126	189	252	315	378
No. ejectors/chutes 3,3 mm pitch		96	192	288	384	480	576
Compressed air consumption (max value at 6 bar)	l/min	320	640	960	1280	1600	1920
	m ³ /h	19	38	58	77	96	115
Compressed air hose	Ø [inch]	1"					
Power supply/frequency	V/Hz	230V - 50/60 Hz					
Power absorption 5 mm pitch (max. value)	A	4	5,9	9,8	11,7	14,6	16,5
Power consumption 5 mm pitch (max. value)	kVA	0,9	1,3	2,1	2,5	3,2	3,6
Power absorption 3,3 mm pitch (max. value)	A	4,3	6,6	10,9	13,1	16,4	18,7
Power consumption 3,3 mm pitch (max. value)	kVA	1	1,5	2,3	2,8	3,6	4
Intake manifold	n°	1	2	2	2	2	2
Manifold diameter	Ø [mm]	100	100	118	118	118	118

ASPIRATION SYSTEM

	1		2		3		4		5		6	
	m ³ /h	l/min	m ³ /h	l/min	m ³ /h	l/min	m ³ /h	l/min	m ³ /h	l/min	m ³ /h	l/min
Air Aspiration	350	5833	700	11666	1050	17500	1400	23333	1750	29166	2100	35000

* For a correct use of the aspiration system consider a head of 150mm of water column (~0.015 bar)

DIMENSIONS (mm/in)

	1		2		3		4		5		6	
	mm	in	mm	in	mm	in	mm	in	mm	in	mm	in
Length	1550	59,45	1550	59,45	2220	87,40	2220	87,40	2900	114	2900	114
Width	1850	72,84	1850	72,84	1850	72,84	1850	72,84	1850	72,84	1850	72,84
Height	2150	84,65	2150	84,65	2150	84,65	2150	84,65	2150	84,65	2150	84,65

WEIGHT (Kg/lbs)

	1		2		3		4		5		6	
	Kg	lbs	Kg	lbs	Kg	lbs	Kg	lbs	Kg	lbs	Kg	lbs
Weigh	970	2138	1050	2315	1220	2690	1300	2866	1520	3351	1600	3527